

LED Position Indicators

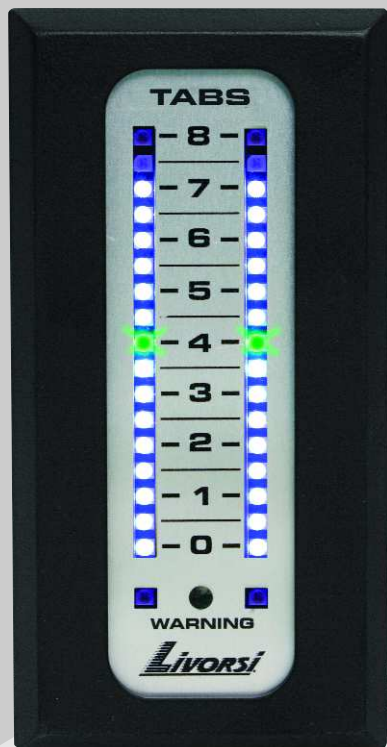

- **Tabs • Drives • Jackplates • Fuel Level •**
- **Water Level • Rudder Indicators •**



- Compatible with NMEA 2000® , SmartCraft® with gateway
- Simple plug and play installation, eliminates clumsy mechanical cables
- No cables means, no loss of motion
- All electronics are environmentally potted
- Indication Options Include:
 - Fill bar type- multiple LEDs lit in a row
 - Pointer type - one LED pointer displays your position/level
- 17 LED lights per slot with a red LED warning light located at the bottom of the slot, which can be used as a warning for resistive type or digital switch senders
- The green LED in the center may be calibrated to show optimal level position (sweet spot) for Drives, Tabs, etc
- Built-in photo sensor automatically adjusts to ambient light with 250 brightness intensity levels
- Has the ability to compensate for non-linear tanks giving you accurate readings
- 0-5 volt or resistive type sensors (adjustable)
- 1 to 4 slot configurations, vertical or horizontal
- Input supply voltage of 12 VDC with reverse polarity protection
- Indicators are available in a variety of colors to match your Livorsi gauges and accessories

These state-of-the-art indicators by Livorsi Marine, Inc. are capable of reading CAN Bus protocols such as SmartCraft® (with gateway), NMEA 2000®, as well as 0-5 volt or resistive-type (ohms) inputs.

Indicator configurations are available in 1, 2, 3 or 4 slots in a vertical or horizontal layout and are environmentally potted to ward out the elements.

Each slot accommodates two analog inputs

Inputs accepted are either 0-5 volts or resistive sensors. These inputs can be transmitted or received from the SmartCraft® (with gateway) or NMEA 2000® network straight into your Garmin, Lowrance, Raymarine or other LED display.

One input drives the 17 LED indicator bar.

The second input (optional) drives the red warning LED located at the bottom of each slot.

Warnings may include: oil pressure, water temperature or low fuel. A normally open or normally closed warning switch is needed in order to activate the warning light.



- running point (sweet spot)
- warning LED with optional sender
- proximity/photo sensor (calibration "button")

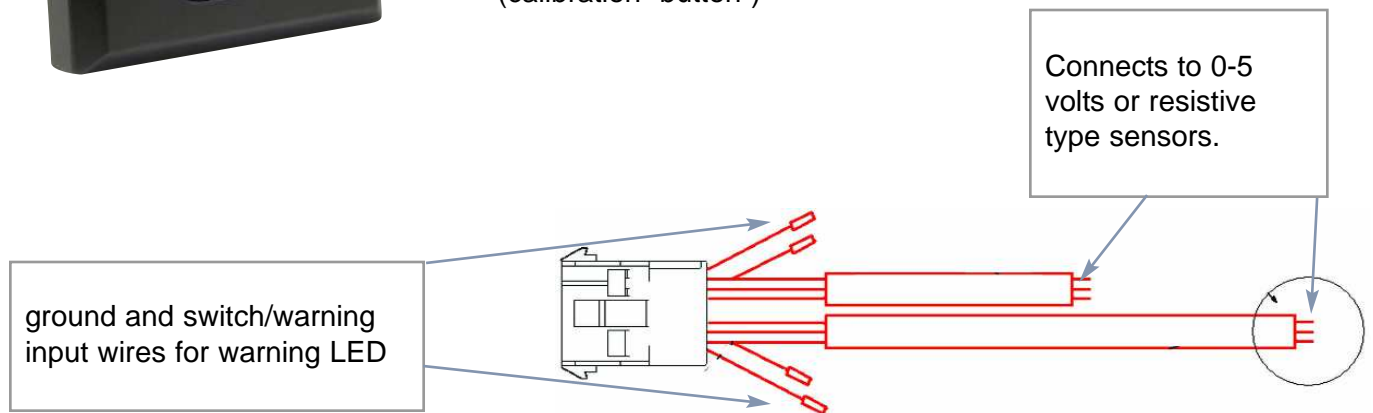

Voltage or Resistance Sensors

Tabs, drives, jack plates, fuel level, water level and rudder indicator applications must have a resistance or voltage type sensor present for this system to operate. Below are some of the options.

Mechanical to Electric Converter 0-5 Volts
(cable not included)

Converts the mechanical signal to an electric signal. Bolts on the inside of the transom with a short cable to the unit.

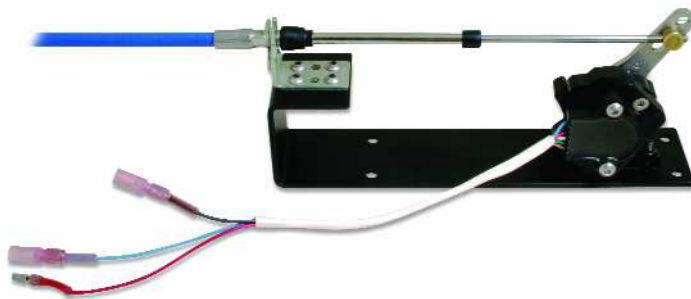

Cables for Mechanical to Electric Converter

33 Series Cables	
3 ft	CA3
4 ft	CA4
5 ft	CA5
6 ft	CA6

Mounted pot on Mercury trim tab 0-5 Volts

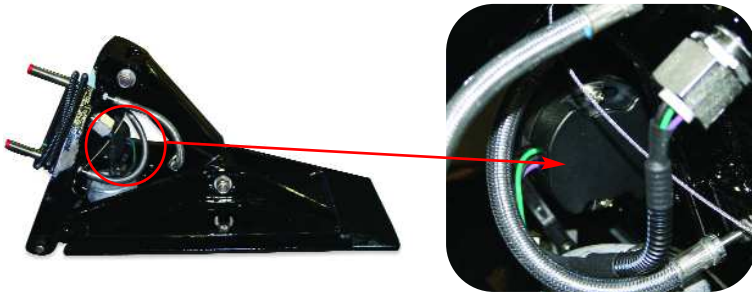

Tabs 2010 or newer should contain the 5 volt sensor
Tabs 2006-2010 model #'s 280S and 380S should have a bracket to add the sensor

See page10 for a list of sensor components

Mercury drive pot 0-5 Volts
Part Number: 863187A1



Retrofitted tabs-
Mercury pot 0-5 Volts
See page 10 for a list of components.



Fuel or water level resistive type sensors
240/33 ohms.
Must know at time of placing your order,
if sender is a 2 or 3 wire sender.

See page 9 for more details

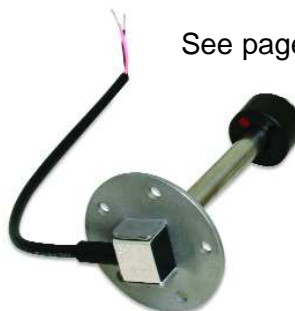

Calibration

Calibration is performed via the proximity/photo sensor on the front of the indicator

- Inputs may be calibrated using either a 2 or 3 point method:
minimum / maximum – or minimum / maximum / center running point (green LED)
- Has the ability to compensate for non-linear tanks (fuel or water),
giving you accurate readings
- Each bar is made of 17 LEDs for high precision resolution (indication)
of the sensor position/level

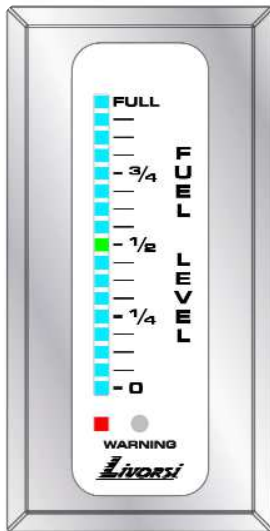

Pointer Style

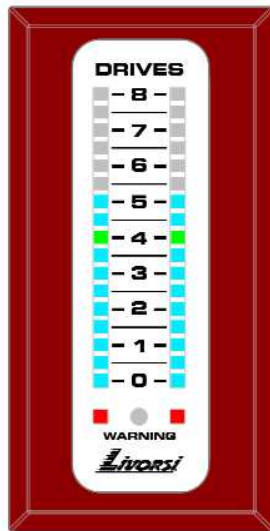

Fill Bar

LED Lighting Options Include:

Pointer Style-
one LED pointer displays your position/level

Fill Bar type-
multiple LEDs lit in a row, beginning from the top or bottom

The green LED in the center may be calibrated to show
optimal level position for Drives, Tabs, etc.

The red LED at the bottom of the indicator can be used as
a warning light

Built-in light sensor automatically adjusts to ambient light
with 250 brightness intensity levels

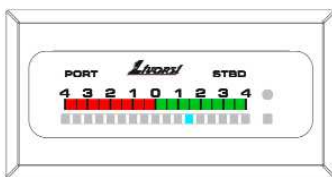

1 or 2 slot

Dimensions

1 or 2 slot indicator: 2 5/8" W x 5 3/16" H overall
requires (2) 1-1/4" cutouts for wiring

3 or 4 slot indicator: 4 1/16" W x 5 7/16" H overall
requires (4) 1-1/4" cutouts for wiring

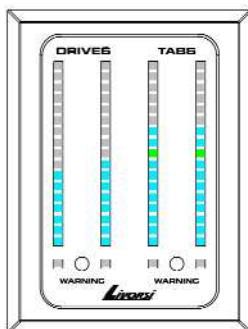

3 or 4 slot

Power Supply

Input supply voltage of 12 VDC,
with reverse polarity protection

Building Your Indicator Part Number

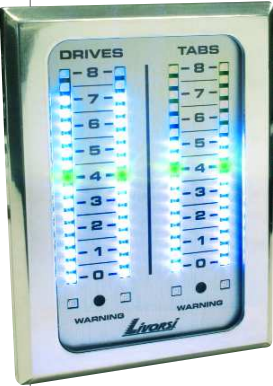
		FIRST ITEM DATA	SECOND ITEM DATA	CARD COLOR	FRAME COLOR	ORIENTATION
		1 or 2 slot	3 or 4 slot			
Part Number	ALEDI	2D	2T	PL	CH	V
		1 Drive = 1D 2 Drives = 2D 1 Tab = 1T 2 Tabs = 2T 1 Fuel = 1F 2 Fuel = 2F 1 Jack Plate = 1J 2 Jack Plate = 2J 1 Rudder = 1R 2 Rudder = 2R	1 Drive = 1D 2 Drives = 2D 3 Drives = 3D 4 Drives = 4D 1 Tab = 1T 2 Tabs = 2T 3 Tabs = 3T 4 Tabs = 4T 1 Fuel = 1F 2 Fuel = 2F 1 Jack Plate = 1J 2 Jack Plate = 2J	Platinum = PL Carbon Fiber = CF Silver Fiber = SF White = W Black = BK	Platinum = PL White = W Black = BK Blue = BL Mustard = MU Red = R Orange = O Lime = L Purple = PU Chrome = CH	Vertical = V Horizontal = H
ALEDI2D2TPLCH						

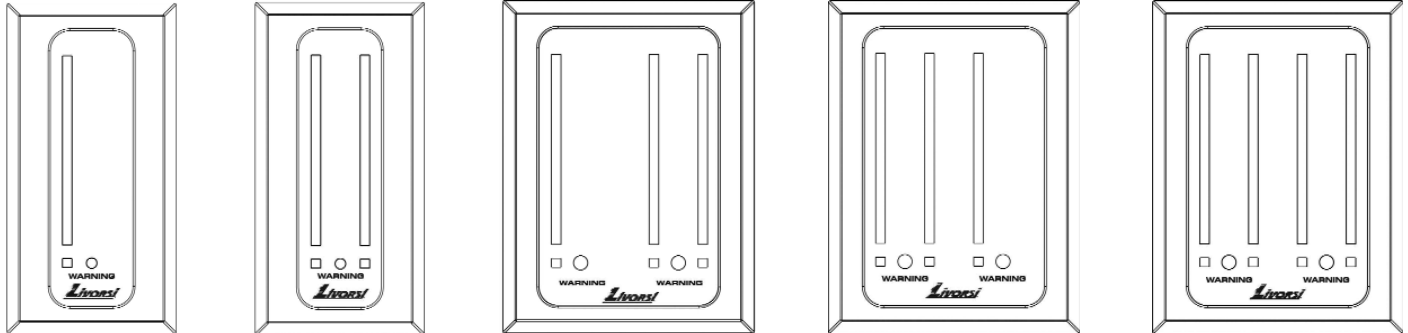



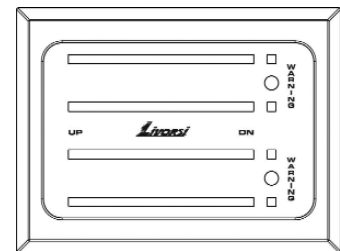
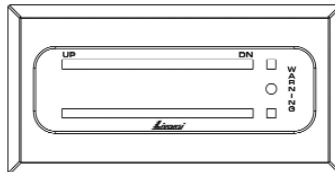
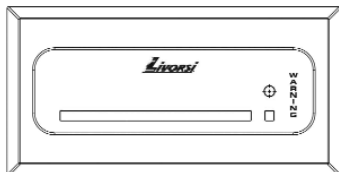

Examples of Horizontal Layouts













Indicator List Price

Description	List Price
1 slot	\$715.00
2 slot	\$822.00
3 slot	\$1,343.00
4 slot	\$1,400.00

Color Options

Card Color  W  PL  BK  CF  SF

Frame Color  BK  BL  W  PL  CH  MU  R  O  L  PU

Parts To Order

1
Indicator



4 slot example:

ALEDI2D2TPLBK

2
Main Harness

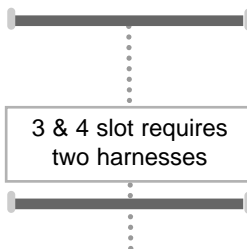

LEDHSA20

3
Jumper Harness

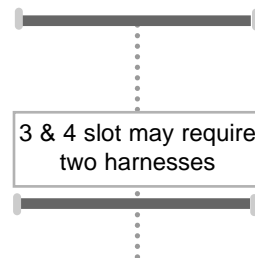

LEDEXT10

Sensor

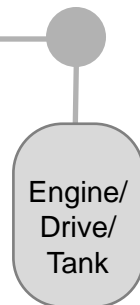

Harness Options		Part Number
	Main Harness to Jumper Harness	
2	a Main Harness 20 feet	LEDHSA20
	b Main Harness 25 feet	LEDHSA25
	c Main Harness 30 feet	LEDHSA30
	d Main Harness 40 feet	LEDHSA40
	Jumper Harness to Sensor Input	
3	a Tab/Drive/Fuel Jumper Single 5 feet	LEDHEXTS
	b Tabs/Drives/Fuel Jumper Dual 10 feet	LEDHEXT10
	c Tabs/Drives/Fuel Jumper Dual 15 feet	LEDHEXT15
	d Mercury SmartCraft® Drive Jumper Single (Y Cable) 5 feet	LEDHYS
	e Mercury SmartCraft® Drive Jumper Dual (Y Cable) 5 feet	LEDHYD5
	f Mercury SmartCraft® Drive Jumper Dual (Y Cable) 10 feet	LEDHYD10
	g Mercury SmartCraft® Drive Jumper Dual (Y Cable) 15 feet	LEDHYD15
	Mechanical to Electric Converter 0-5 Volts	call for part number
	Fuel or Water Level Sensors- see page 11	

NOTE: Before ordering your Mercury SmartCraft® Drive Jumper harness, first verify which type of drive sensor you have: the 3-wire 0-5 volt sensor or the 2-wire resistive sensor.

Main Harnesses

2a, 2b, 2c, 2d - LEDHSA 10, 20, 25, 30, 40
(Rev F)

DIM XX	Length
10	10 feet
20	20 feet
25	25 feet
30	30 feet
40	40 feet

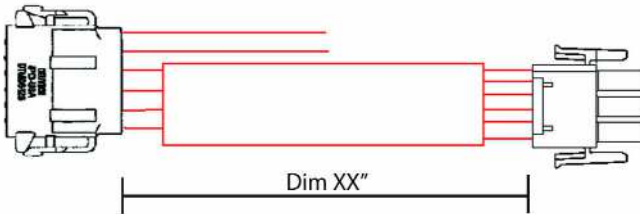

Pin Layout

3	2	1
6	5	4
9	8	7

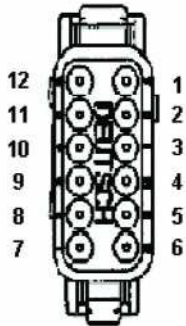
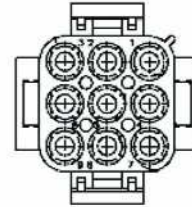

2	Lt Blue	from NMEA
11	White	
1	18 Ga Black	
12	18 Ga Red	
3	22 Ga Black	
4	22 Ga Green	
5	22 Ga Red	
8	22 Ga Brown	
6	22 Ga Orange	
7	22 Ga White	
9	22 Ga Yellow	
10	22 Ga Blue	

1	Black (Port GND)
2	Green (Port Analog)
3	Blue (port +5V)
4	Orange (Stbd GND)
5	Red (Stbd Analog)
6	White (Stbd +5V)
7	Brown (Stbd LED)
8	No Connection
9	Yellow (Port LED)

Jumper Harnesses

3a - LEDHEXTS
(Rev C)

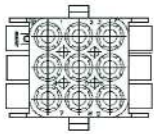
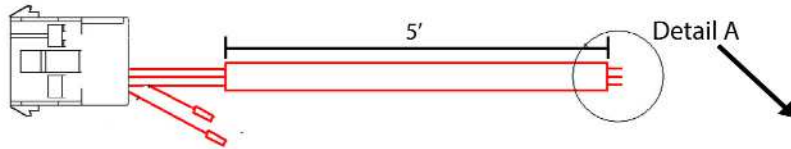

Pin Layout

1	2	3
4	5	6
7	8	9

1	Black (GND) 6" pigtail (Label GND)
2	Green (Analog)
3	White (+5) (Label POS)
4	
5	
6	No Connection
7	
8	
9	6" pigtail- Violet (Switch/Warning)

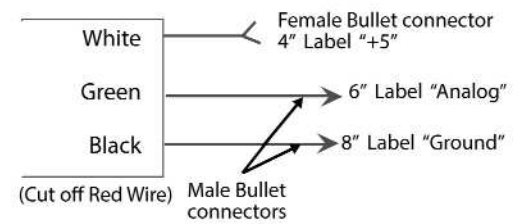

3b, 3c - LEDHEXT10, LEDHEXT15
(Rev C)

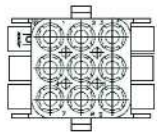
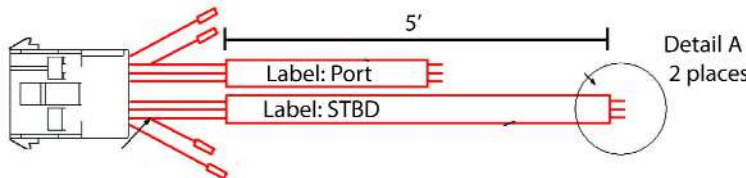

Pin Layout

1	2	3
4	5	6
7	8	9

1	Black (GND 1) 6" pigtail (Label GND1)	Port Side: Long Wire
2	Green (Analog 1)	
3	White (+5) (Label POS 1)	
4	Black (GND 2) 6" pigtail (Label GND 2)	Stbd Side: Short Wire
5	Green (Analog 2)	
6	White (+5) (Label POS 2)	
7	6" pigtail- Brown (Stbd Switch/Warning)	
8	No Connection	
9	6" pigtail- Violet (Port Switch/Warning)	

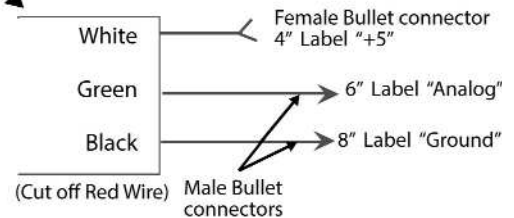

DIM XX	Length
10	10 feet
15	15 feet

Jumper Harnesses

3d - LEDHYS
(Rev D)

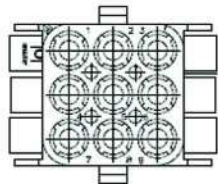
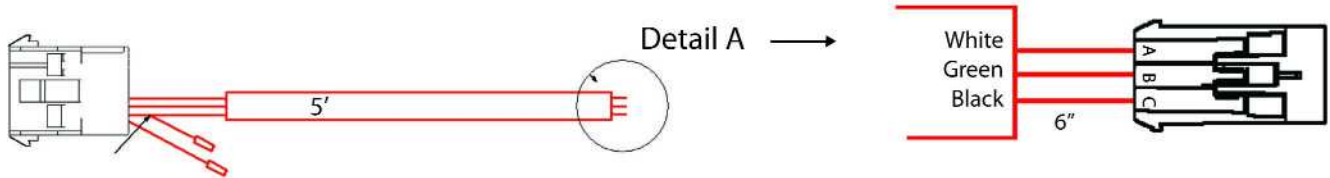

Pin Layout

1	2	3
4	5	6
7	8	9

1	Black (GND) 6" pigtail (Label GND)
2	Green (Analog)
3	White (+5) (Label POS)
4	
5	
6	No Connection
7	
8	
9	6" pigtail- Violet (Switch/Warning)

3e, 3f, 3g - LEDHYD5, LEDHYD10, LEDHYD15
(Rev D)

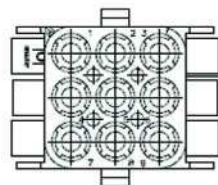
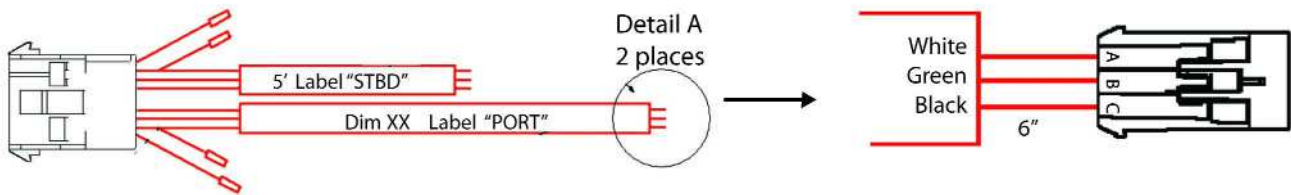

Pin Layout

1	2	3
4	5	6
7	8	9

1	Black (GND 1) 6" pigtail (Label GND1)	Port Side: Long Wire
2	Green (Analog 1)	
3	White (+5) (Label POS 1)	
4	Black (GND 2) 6" pigtail (Label GND 2)	Stbd Side: Short Wire
5	Green (Analog 2)	
6	White (+5) (Label POS 2)	
7	6" pigtail- Brown (Stbd Switch/Warning)	
8	No Connection	
9	6" pigtail- Violet (Port Switch/Warning)	

DIM XX	Length
5	5 feet
10	10 feet
15	15 feet

Mercury Trim Tab Sensor 0-5 Volt Components

Ref	Part	Description	Qty
1	840846	Housing, actuator arm support	1
2	89766	Screw, #10-31 x .620 stainless steel	2
3	859080	Washer	2
4	859124	Nut, #10-32 stainless steel	2
5	840845	Arm, Actuator	1
6	863187A04	Sender Assembly, Trim	1
7	57008	Retainer	2
8	26996	Lock washer, #10, stainless steel	2
9	37978	Screw #10-32 x .750 stainless	2
10	840843	Link rod	1
11	65110	Nut	1
12	89302	Washer, .203 x .406 x .040	1
13	21071 1	Cotter pin	1
14	67297	Pin, Clevis	1
15	891578	Bracket, Trim tab	1
16	85486	Screw, .250-20 x .380 stainless steel	2
17	895820T02	Harness assembly	1

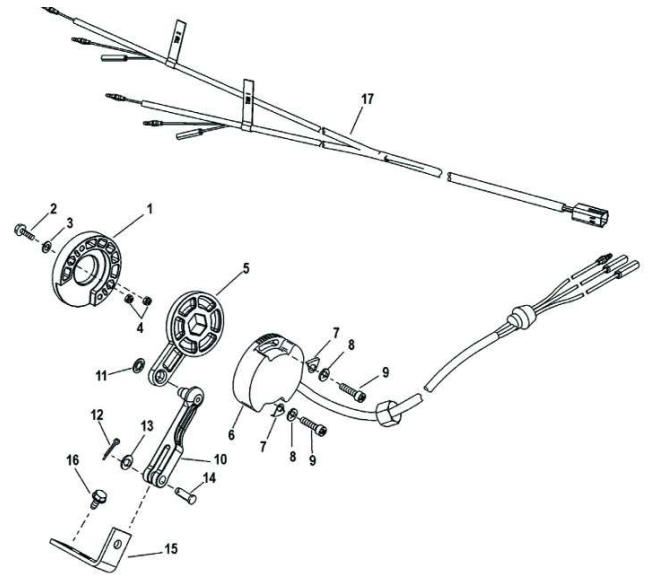

Tabs 2006-2010 model #'s 280S and 380S should have a bracket to add the sensor.

Recommended Fuel and Water Level Sensor

Be sure to check what type of level sensor is presently installed. 2 or 3 wire sensor. Type must be known at time of placing your order, for proper indicator compatibility.



Gas, Diesel or Water Level Sensors

- Suitable for Gas, Diesel or Water
- 316 Stainless Steel
- SAE 5 Hole Pattern
- 240-33 OHMS
- Constructed to meet and/or exceed all applicable ISO, NMMA, ABYC and USCG standards

SFW + length



Livorsi Marine, Inc
715 Center Street
Grayslake IL 60030

P: 847.752.2700
info@livorsi.com
www.livorsi.com

**For more information please
contact one of our sales reps:**

Mike Livorsi
mikel@livorsi.com
847.752.2710

Marty Alexonis
martya@livorsi.com
847.752.2706

Fred Ortega
fredo@livorsi.com
847.752.2705

Tom Veronneau
West Coast Sales Rep
tomv@comp.com
951.323.9756



SAE J1939

